

TRASH RECEPTACLE - 22"

ASSEMBLY INSTRUCTIONS

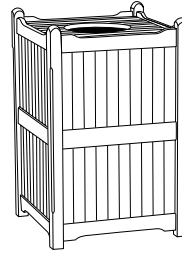

COMPONENTS

- ① Side Panel with Posts
Quantity: 2



- ② Side Panels without Posts
Quantity: 2

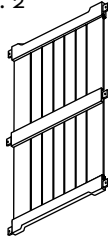

- ③ Base
Quantity: 1

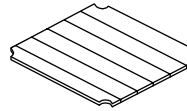

- ④ Lid with Hole
Quantity: 1

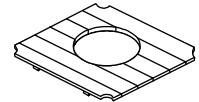

- ⑤ Liner
Quantity: 1

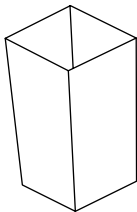

HARDWARE

- Ⓐ Dowels
Quantity: 26



FINISHING ITEMS

Medium Grit Sandpaper

NOTE: If the furniture is going to be placed on a concrete or tile patio, it should first be rinsed well to remove the sawdust that may cause some staining.

NOTE: A hammer (not provided) will be needed for the assembly of this trash receptacle.

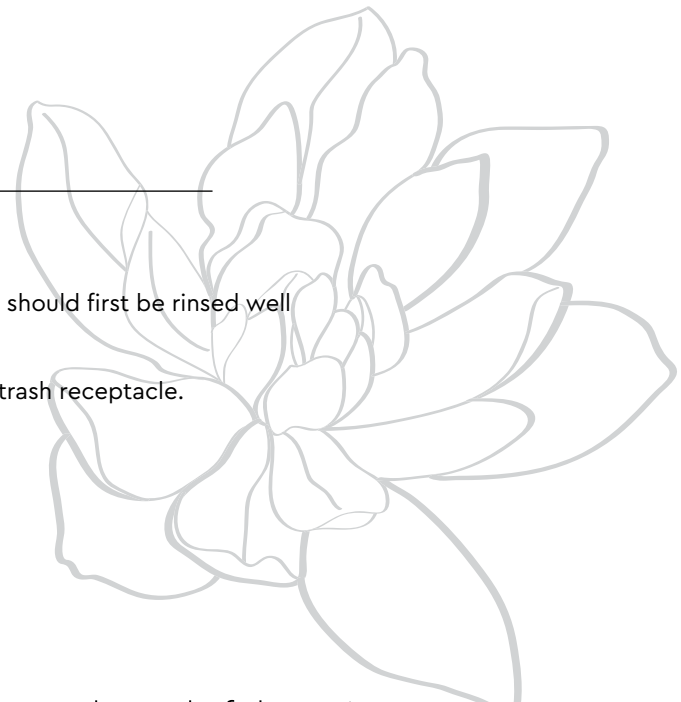

Thoughtful Design **MADE RIGHT**

INSTRUCTIONS

STEP 1

Place Side Panels without posts ② into mortise holes on the Side Panels with Posts ①.

NOTE: One Side of Each Side Panel has a notched groove between slats. This side faces outward.

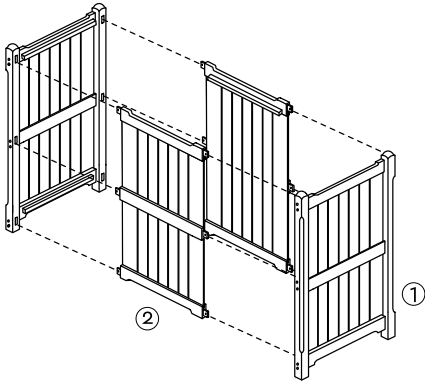

STEP 2

With a hammer, drive 24 **A** dowels into the predrilled holes. Insert the tapered end of the dowel first.

NOTE: The dowels should be easily driven in flush.

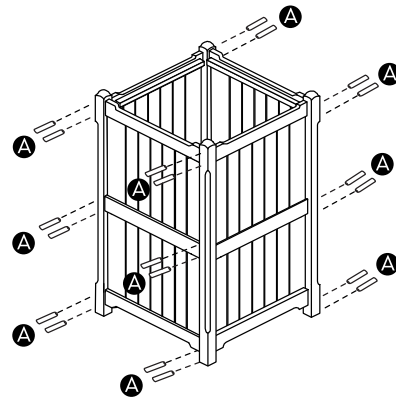

STEP 3

Place Base ③ onto wood supports on the Side Panel with Posts.

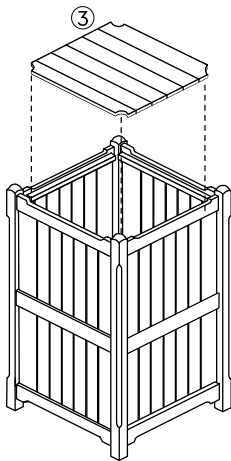

STEP 4

Place Liner ⑤ into assembled trash receptacle.

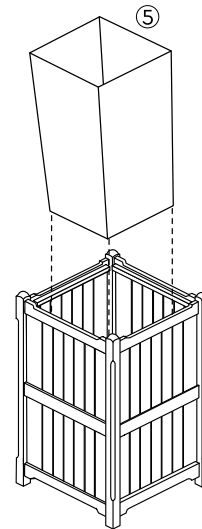

STEP 5

Place lid with the hole ④ onto wood supports on the Side Panel with Posts.

