

TRAVIRA MODULAR HOST STAND TOPPER
ASSEMBLY INSTRUCTIONS

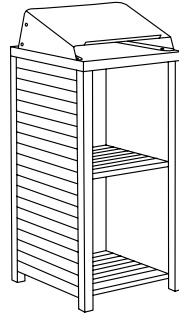

COMPONENTS

- ① Travira Modular Host Stand Topper
Quantity: 1

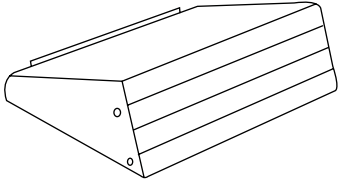

HARDWARE

- A Short Bolt
Quantity: 4



- B Allen Wrench
Quantity: 1

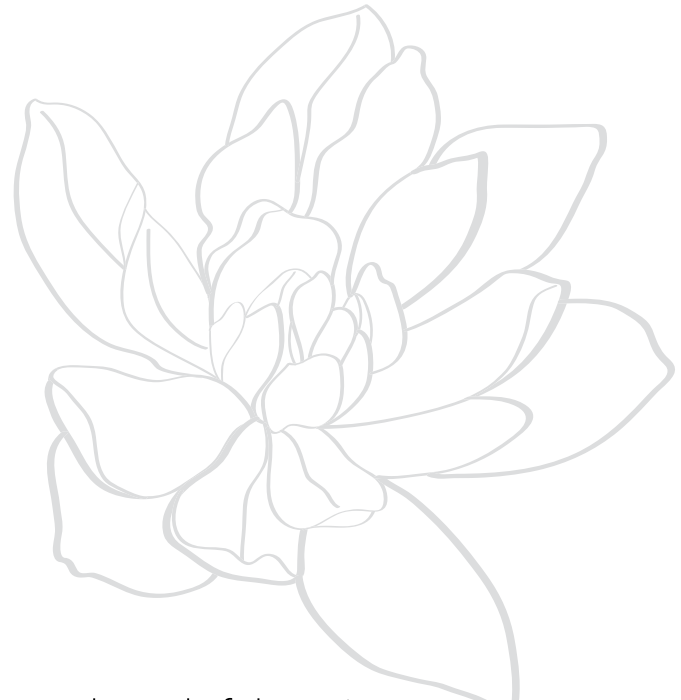
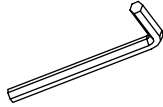

Thoughtful Design **MADE RIGHT**

INSTRUCTIONS

STEP 1

It is recommended to first unscrew and remove the Tekwood panel by removing 4 bolts from the topper ① and set aside.

Note: This is so it is easier to attach the topper to stand.

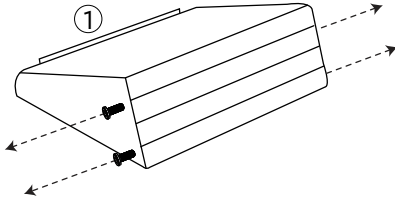

STEP 2

Place the host stand topper ① on top of the Modular Valet Base. Making sure it is facing the correct direction. Align the bottom mounting bolt holes with the base's top 4 insert nuts.

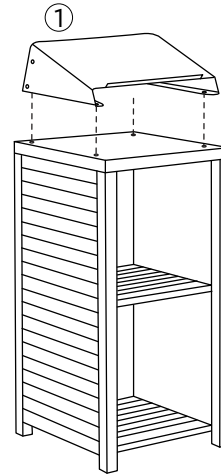

STEP 3

Take the 4 bolts A out of the bag. Using the provided allen wrench B, bolt the host stand topper tightly to the base.

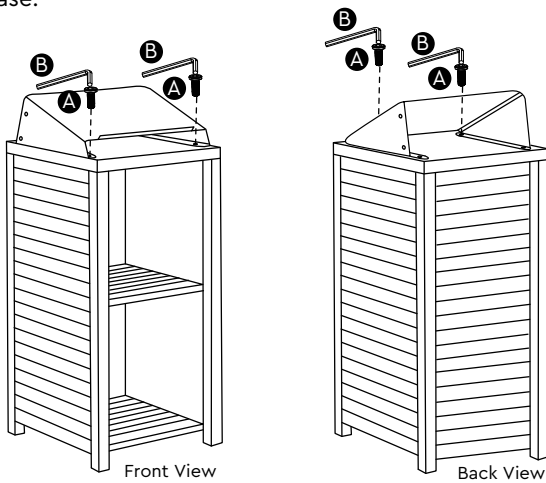

STEP 4

Align the Tekwood panel back on the aluminum stand topper and bolt on using the 4 bolts on each side that were previously removed.

