

SIENA SIDE TABLE

ASSEMBLY INSTRUCTIONS

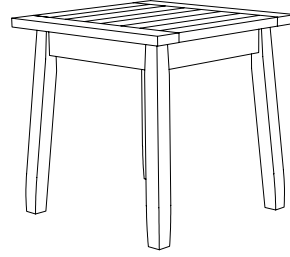

COMPONENTS

- ① Table Top
Quantity: 1

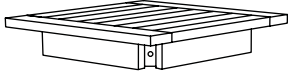

- ② Leg
Quantity: 4

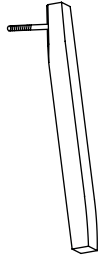

HARDWARE

- A Washers
Quantity: 4



- B Hex Nuts
Quantity: 4



- C Hex Head Wrench
Quantity: 1

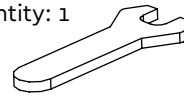

FINISHING ITEMS

Medium Grit Sandpaper

NOTE: If the furniture is going to be placed on a concrete or tile patio, it should first be rinsed well to remove the sawdust that may cause some staining.

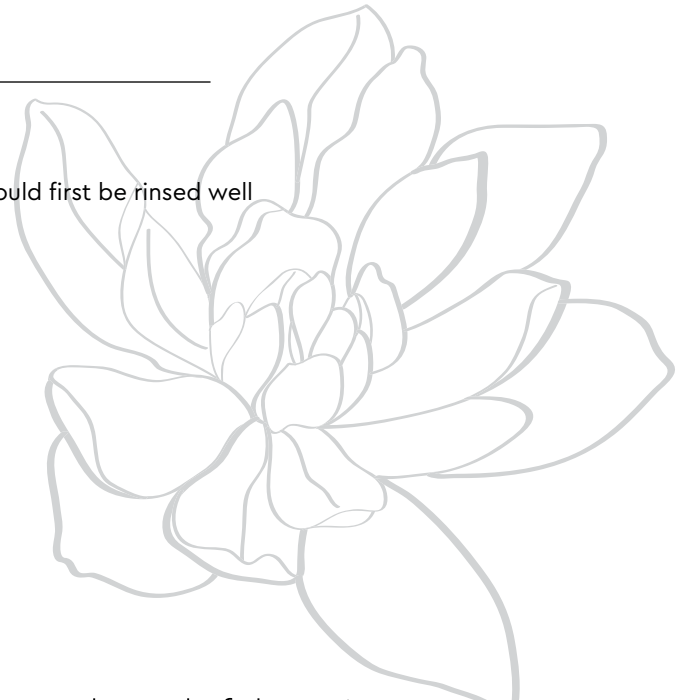

Thoughtful Design **MADE RIGHT**

INSTRUCTIONS

STEP 1

On a clean flat surface, lay table top ① upside down.

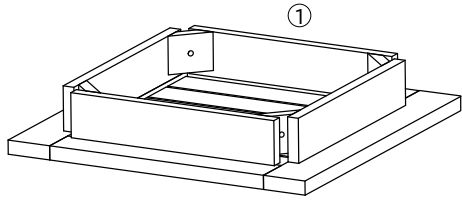

STEP 2

Place the bolt of one leg ② through the holes in the corner brace of table top ①. Slide one metal washer A onto the bolt. Screw one hexagon nut B onto the bolt and tighten with wrench (supplied). Repeat for other three legs.

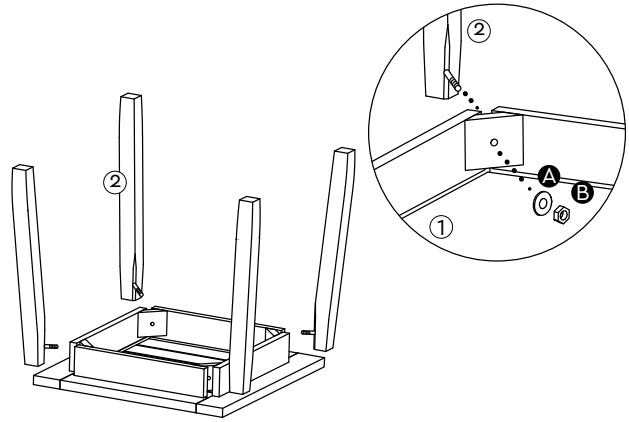

STEP 3

Turn table upright and enjoy.

