

OXFORD BACKLESS 5' BENCH
ASSEMBLY INSTRUCTIONS

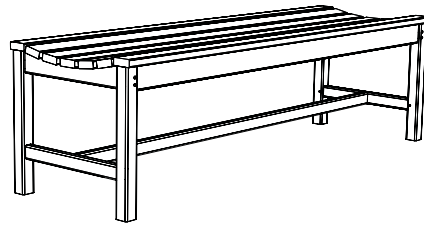

COMPONENTS

- ① Right Leg Assembly
Quantity: 1

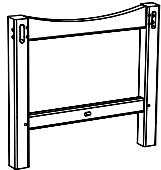

- ② Left Leg Assembly
Quantity: 1

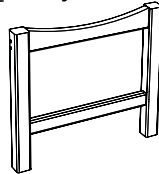

- ③ Seat
Quantity: 1

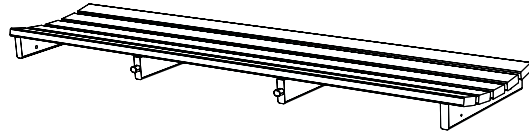

- ④ Back Seat Rail
Quantity: 1

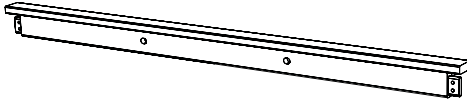

- ⑤ Front Seat Rail
Quantity: 1

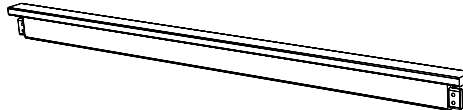

- ⑥ Bottom Rail
Quantity: 1



HARDWARE

- A Dowel
Quantity: 10



- B Wood Screw
Quantity: 12



FINISHING ITEMS

Medium Grit Sandpaper

NOTE: Hardware pack may contain more hardware than what is needed to assemble.

A hammer and phillips head screw driver (not provided) will be needed for the assembly of this bench.

If the furniture is going to be placed on a concrete or tile patio, it should first be rinsed well to remove the sawdust that may cause some staining.

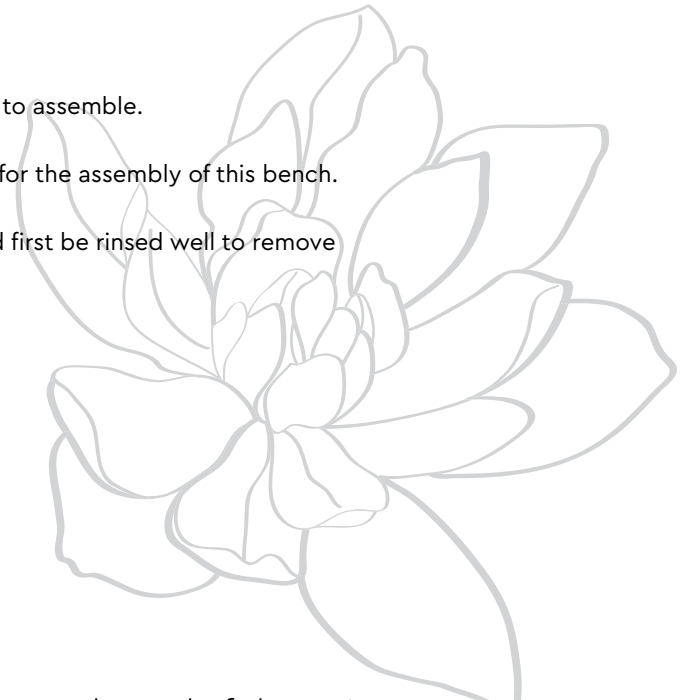

Thoughtful Design **MADE RIGHT**

INSTRUCTIONS

STEP 1

On a clean flat surface, lay right leg assembly ① on its side mortise holes facing up. Locate the small label on the bottom of the seat that reads "front". With the front of the seat toward the front of the bench, line up and insert the front seat rail ⑤ and seat ③ into the right leg assembly. Insert the large rounded pegs at the front of the seat into the front seat rail.

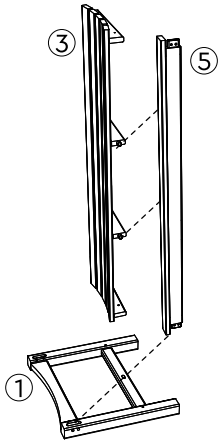

STEP 2

Place back seat rail ④ into position, holes facing inward. Insert the large rounded pegs at the back of the seat into the back seat rail.

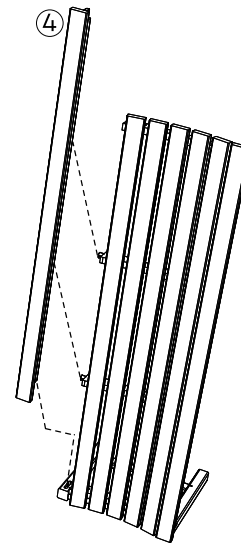

STEP 3

Insert the tenon of the bottom rail ⑥ into the mortise of the right arm assembly.

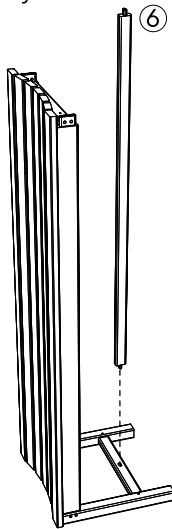

STEP 4

Insert the left leg assembly ② into the rest of the assembled parts. Secure the bottom rail by inserting a wood screw ⑧ through the under part of each leg as shown in figure 1 below.

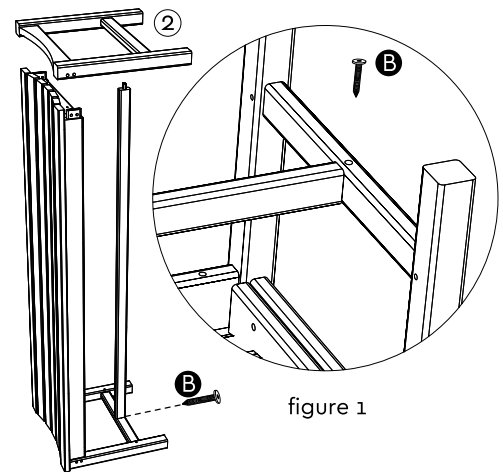

STEP 5

With a hammer, drive 8 dowels ⑨ into the predrilled holes as shown. NOTE: Insert the tapered end of the dowels first. The dowels should be easily driven in flush. If there is strong resistance, do not force the dowel. Sand to smooth off areas around the dowel pins.

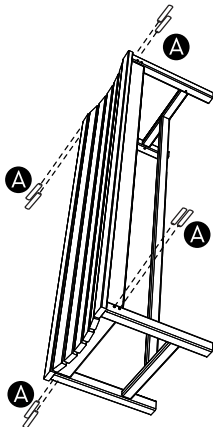

STEP 6

Using a phillips head screwdriver screw the 8 total wood screws ⑩ into the predrilled holes on the underside of the seat to attach the seat to the seat back, front rail and leg assemblies as shown.

