

48" ROUND DINING TABLE

ASSEMBLY INSTRUCTIONS

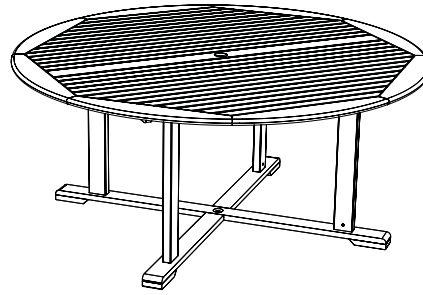

COMPONENTS

- ① Table Top Assembly
Quantity: 1

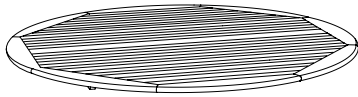

- ② Corner Posts
Quantity: 4



- ③ Pedestal Base
Quantity: 1

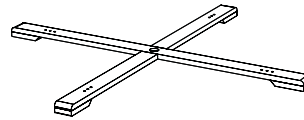

- ④ Parasol Hole Cap
Quantity: 1



HARDWARE

- A Metal Washers
Quantity: 8



- B Hex Nuts
Quantity: 8



- C Machine Bolts
Quantity: 5



- D Barrel Nuts
Quantity: 4



- E Allen Wrench
Quantity: 2

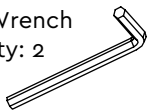

- F Hex Head Wrench
Quantity: 1

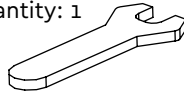

FINISHING ITEMS

Medium Grit Sandpaper

If the furniture is going to be placed on a concrete or tile patio, it should first be rinsed well to remove the sawdust that may cause some staining.

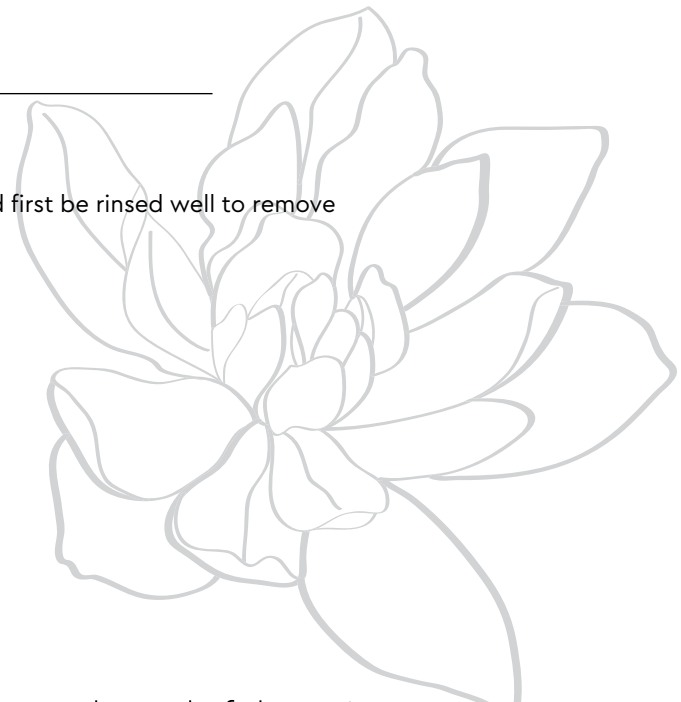

Thoughtful Design **MADE RIGHT**

INSTRUCTIONS

STEP 1

Lay table top ① upside down on a clean, flat surface. Insert the threaded rods on one corner post ② into holes located on one corner of table top.

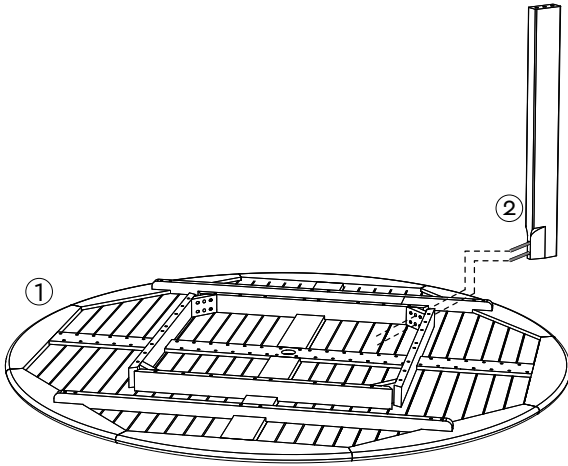

STEP 2

Secure corner post to the table top using two of the metal washers (A) and two of the Hex Nuts (B) with the Hex Wrench provided. Repeat Steps 1-2 for the remaining corner posts.

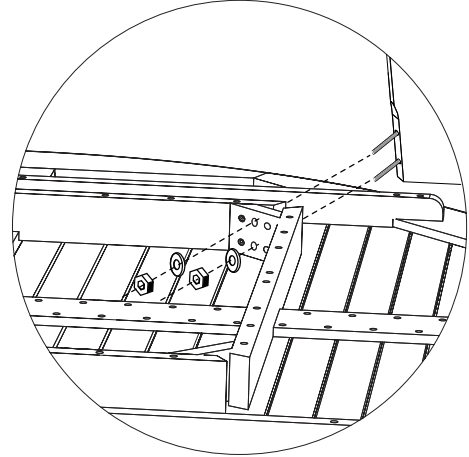

STEP 3

Position pedestal base ③ onto legs as shown. Insert one barrel nut (D) into hole on the side of a leg. Align the barrel nut to receive the machine bolt (C) through the pedestal base and into the leg.

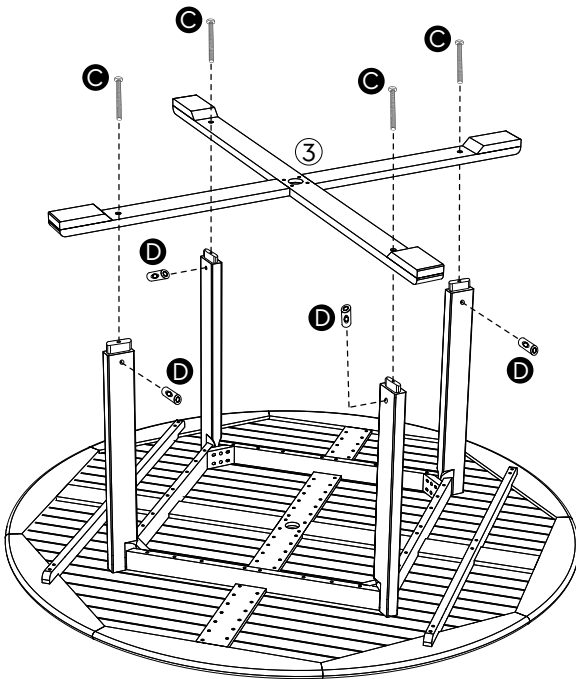

How to align barrel nuts and bolts

Insert a guiding bolt into the end of a barrel nut



Align the barrel nut inside of the component with the bolt used to connect the components

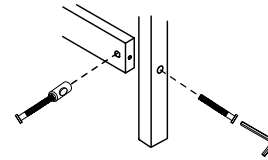

Once the component bolt is aligned and threaded, simply pull the guiding bolt from the end of the barrel nut.

STEP 4

Tighten Bolt with allen wrench and repeat for remaining legs.

STEP 5

Turn upright and enjoy!