

NETTE BAR CHAIR

ASSEMBLY INSTRUCTIONS

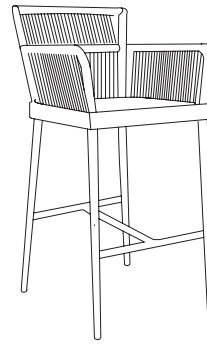

COMPONENTS

- ① Bar Chair Back & Arm Assembly
Quantity: 1

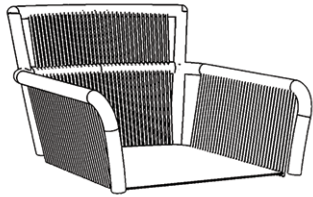

- ② Bar Chair Seat & Leg Assembly
Quantity: 1

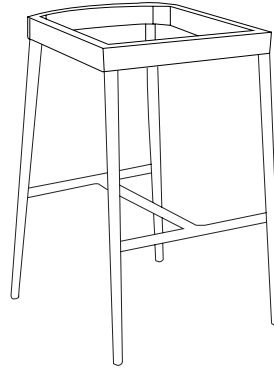

HARDWARE

- A Long Bolts
Quantity: 3

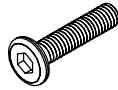

- B Allen Wrench
Quantity: 1

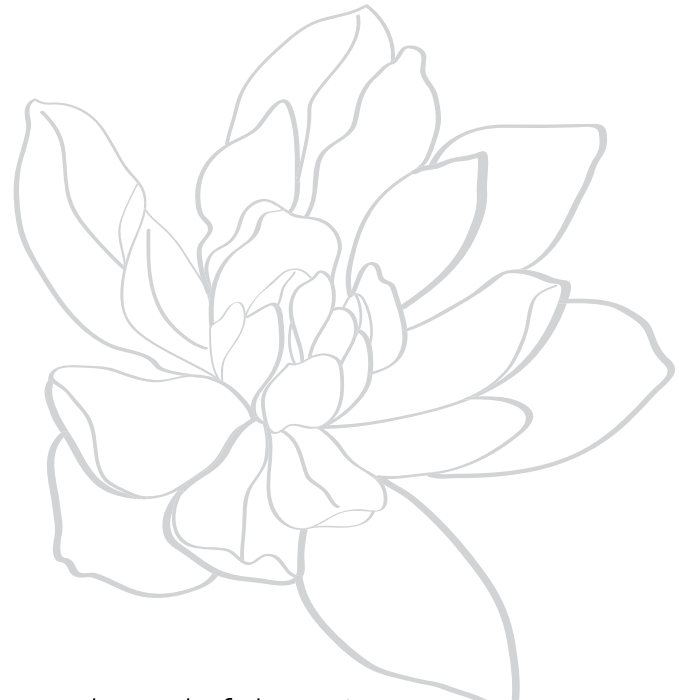
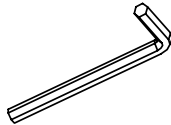

Thoughtful Design **MADE RIGHT**

INSTRUCTIONS

STEP 1:

Place Bar Chair Back & Arm Assembly ① upside down on top of provided cardboard box or blanket to protect the surface of the chair while assembling.

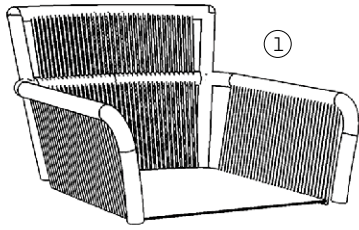

STEP 2:

Align Bar Chair Back & Arm Assembly ① with Bar Chair & Leg Assembly ②. Using the wrench **B** provided, secure with bolts **A**. NOTE: Leave bolts slightly loose to help with alignment of the chair seat assembly.

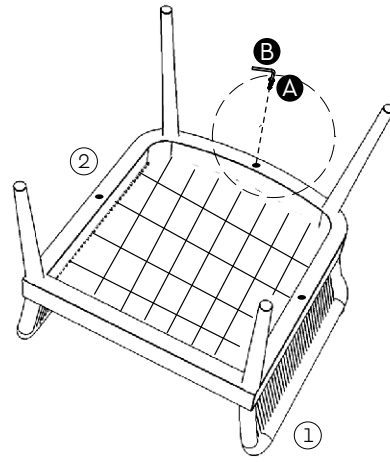

STEP 2 (detail):

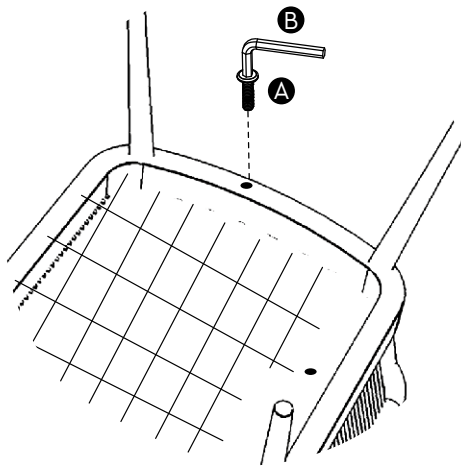

STEP 3:

Carefully turn assembled Bar Chair in an upright position.

