

CLASSIC 6' BENCH

ASSEMBLY INSTRUCTIONS

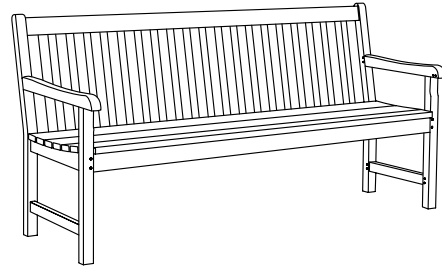

COMPONENTS

- ① Right Arm Assembly
Quantity: 1

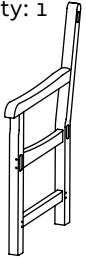

- ② Left Arm Assembly
Quantity: 1

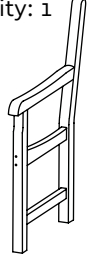

- ③ Back
Quantity: 1

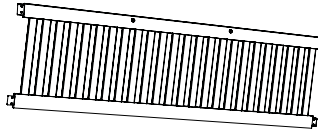

- ④ Seat
Quantity: 1

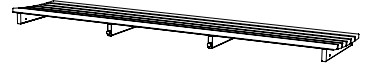

- ⑤ Front Rail
Quantity: 1



HARDWARE

- A** Dowels
Quantity: 14



- B** Wood Screws
Quantity: 10



FINISHING ITEMS

Medium Grit Sandpaper.

NOTE: Hardware pack may contain more hardware than what is needed to assemble.

A hammer and a phillips head screwdriver (not provided) will be needed for the assembly of this bench.

NOTE: If the furniture is going to be placed on a concrete or tile patio, it should first be rinsed well to remove the sawdust that may cause some staining.

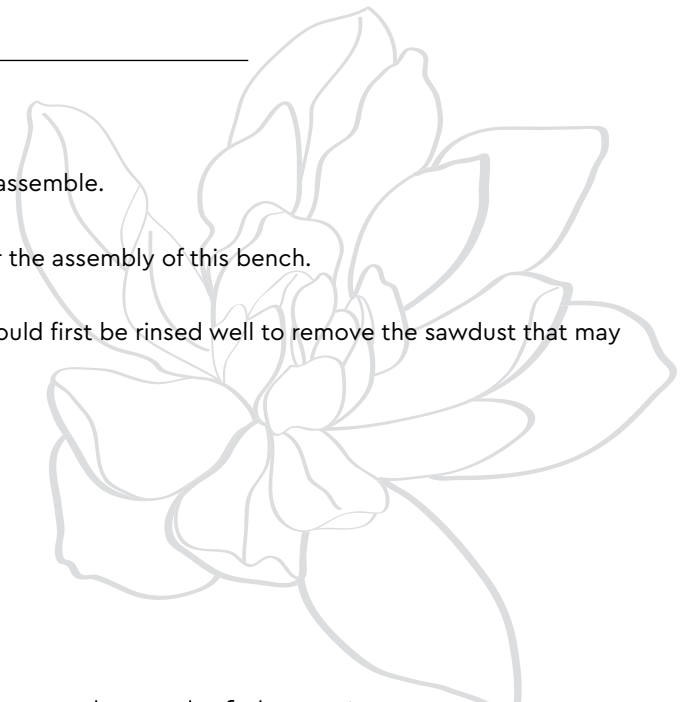

Thoughtful Design **MADE RIGHT**

INSTRUCTIONS

STEP 1

On a clean flat surface, lay right leg assembly ① on its side mortise holes facing up. Place the back ③ into the mortise of the right leg assembly.

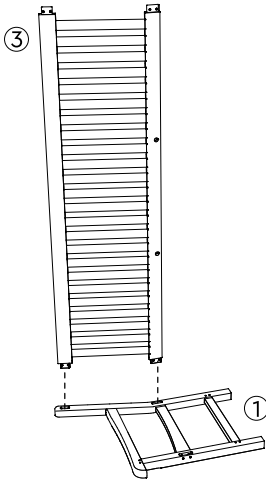

STEP 2

Locate the small label on the bottom of the seat that reads "front". With the front of the seat toward the front of the bench, line up and insert the front rail ⑤ and seat ④ into the right leg assembly. Insert the large rounded pegs at the front and rear of the seat into the back and front rail.

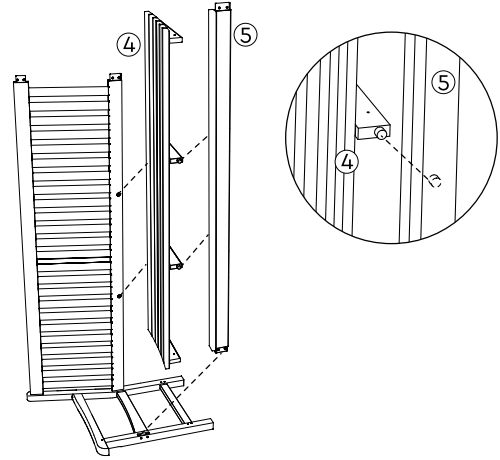

STEP 3

Line up and place left leg assembly ② onto those parts already assembled.

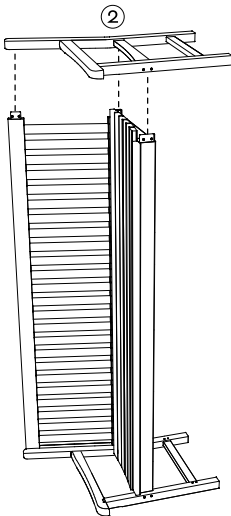

STEP 4

With a hammer, drive 4 dowels A into the predrilled holes found on the front of the leg assemblies to hold the front rail ⑤ into place. Drive the remaining 8 dowels into the predrilled holes located on the back of the leg assemblies to hold the back ③ in place. Insert the tapered end of the dowels first.

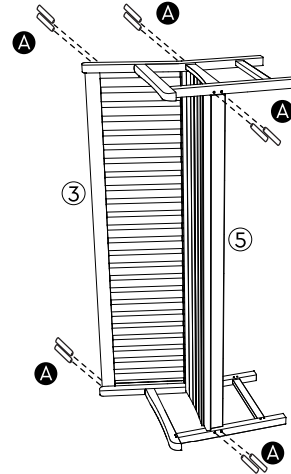

STEP 4 (detail)

Note: The dowels should be easily driven in flush. If there is strong resistance, do not force the dowel. Sand to smooth off areas around the dowel pins.

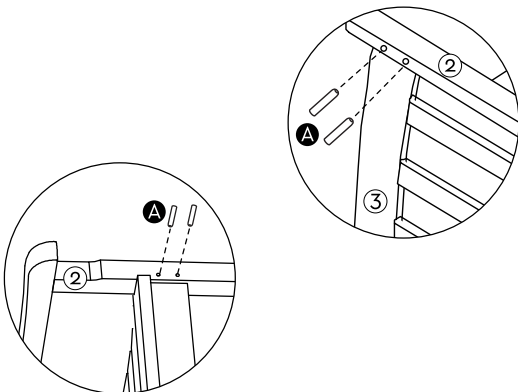

STEP 5

Using a phillips head screwdriver, screw the 8 total wood screws B into the predrilled holes on the underside of the seat to attach the seat to the seat back, front rail and arm assemblies as shown. Turn bench upright and enjoy!

